

# Beta 16

2 Cylindres - 599cc - 16CV max à 3 600 tr/min - 95Kg

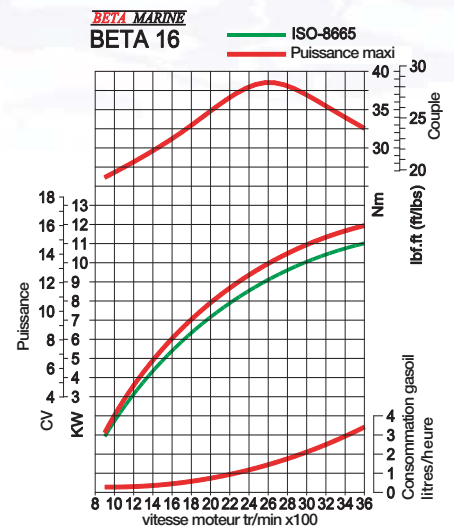
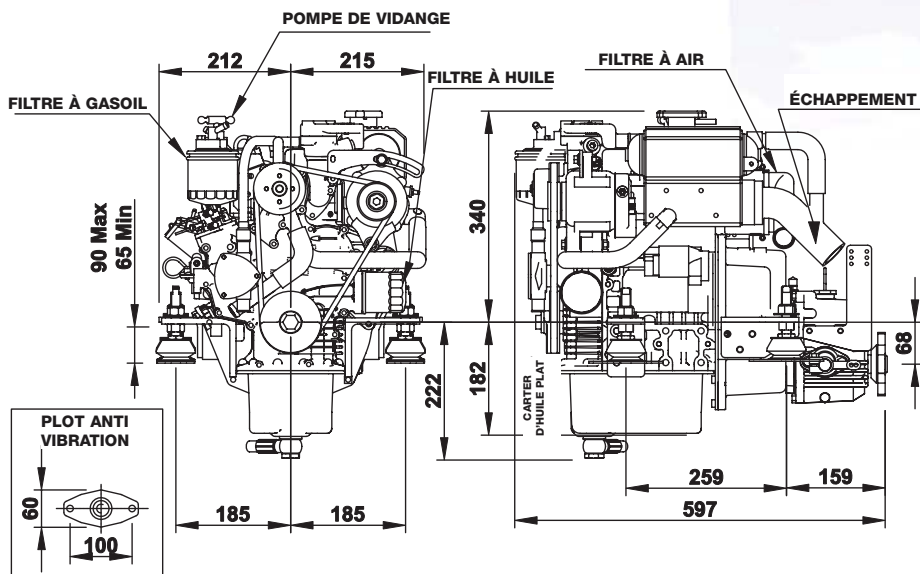
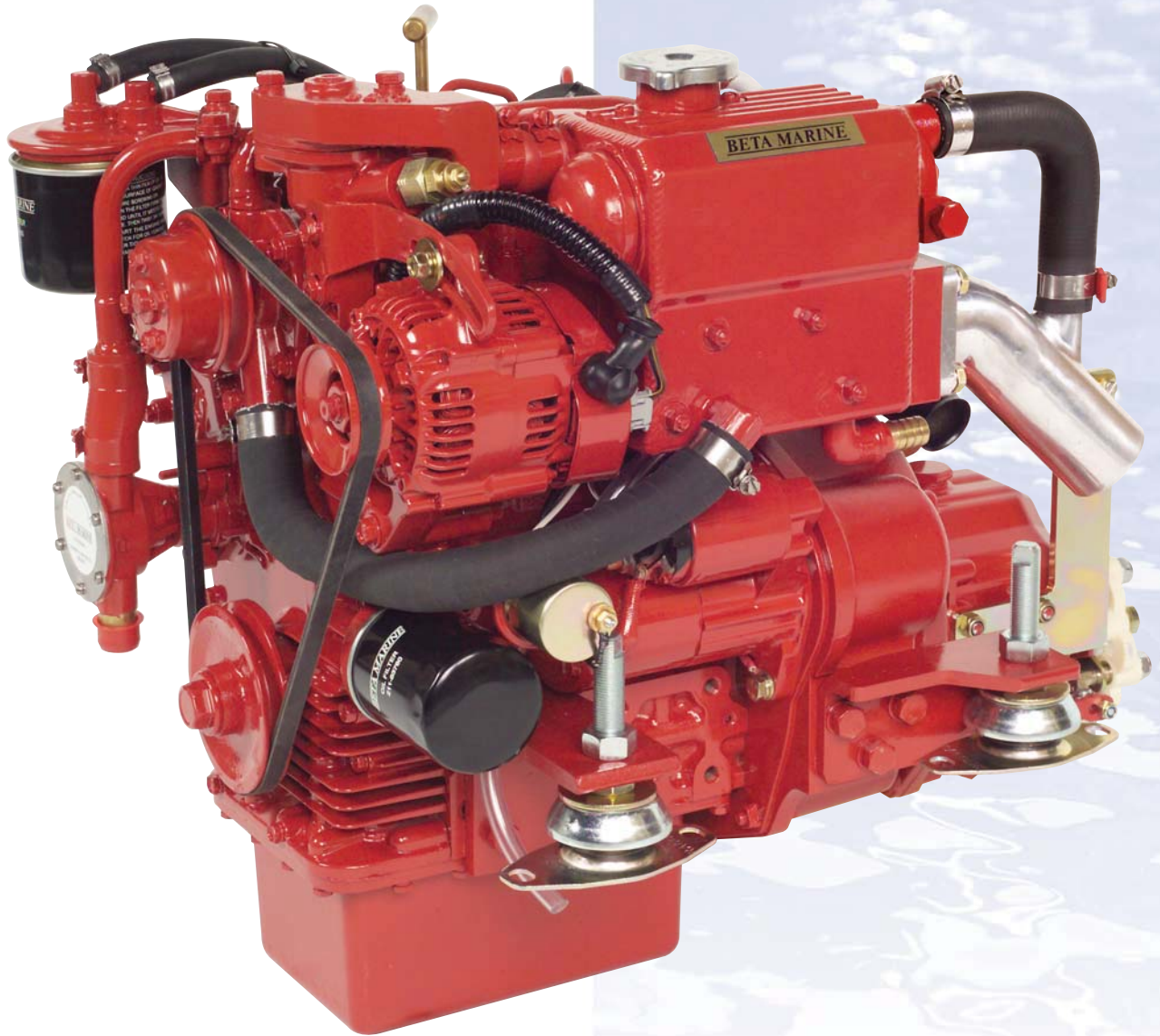

CONSOMMATION GASOIL CORRESPONDANT À UNE CHARGE THÉORIQUE D'HELICE À PLEINE VITESSE