

Beta 25

3 Cylindres - 898cc - 25CV max à 3 600 tr/min - 113Kg

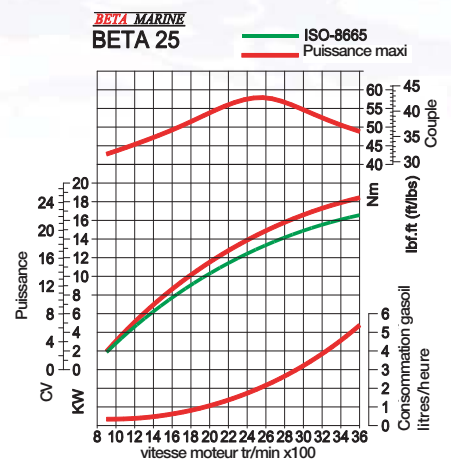
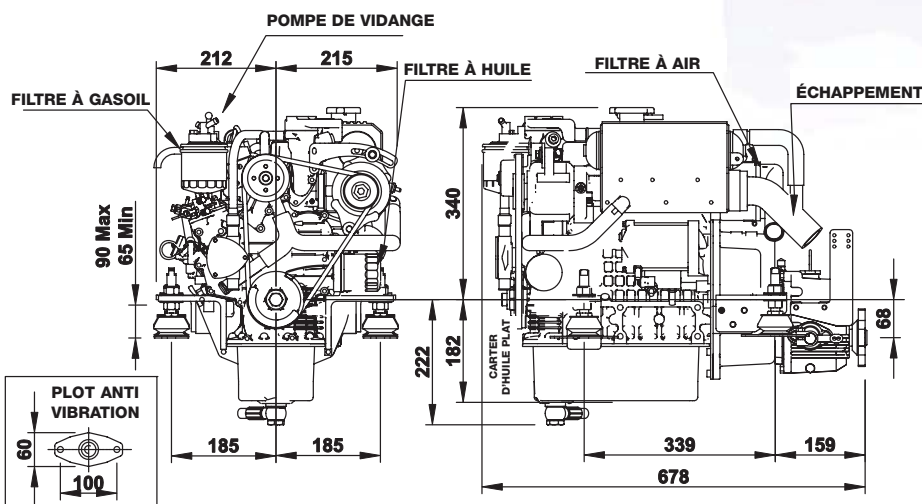

CONSUMATION GASOIL CORRESPONDANT À UNE CHARGE THÉORIQUE D'HÉLICE À PLEINE VITESSE