

Beta 60

4 Cylindres - 2434cc - 56CV max à 2 700 tr/min - 287Kg

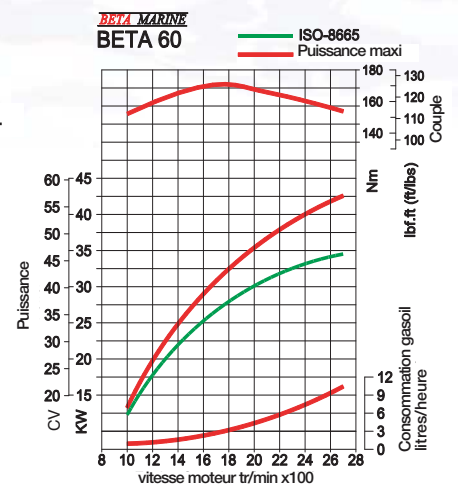
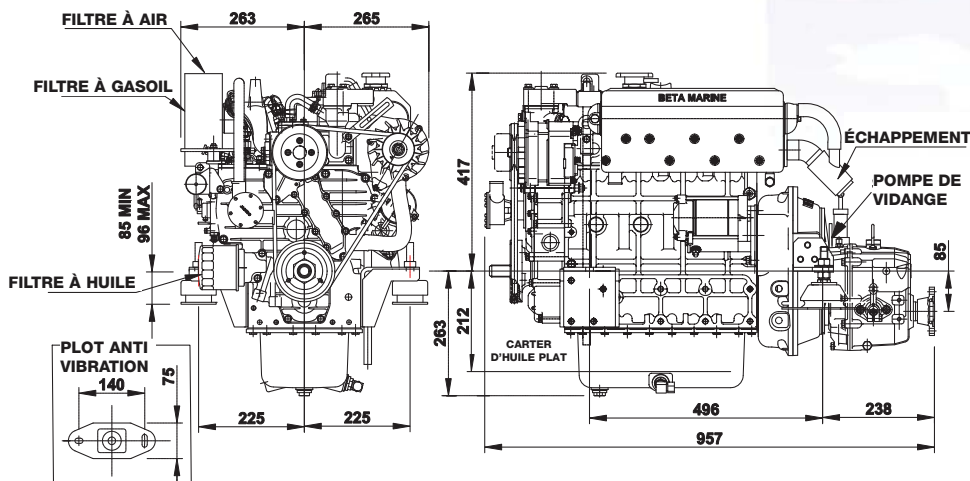
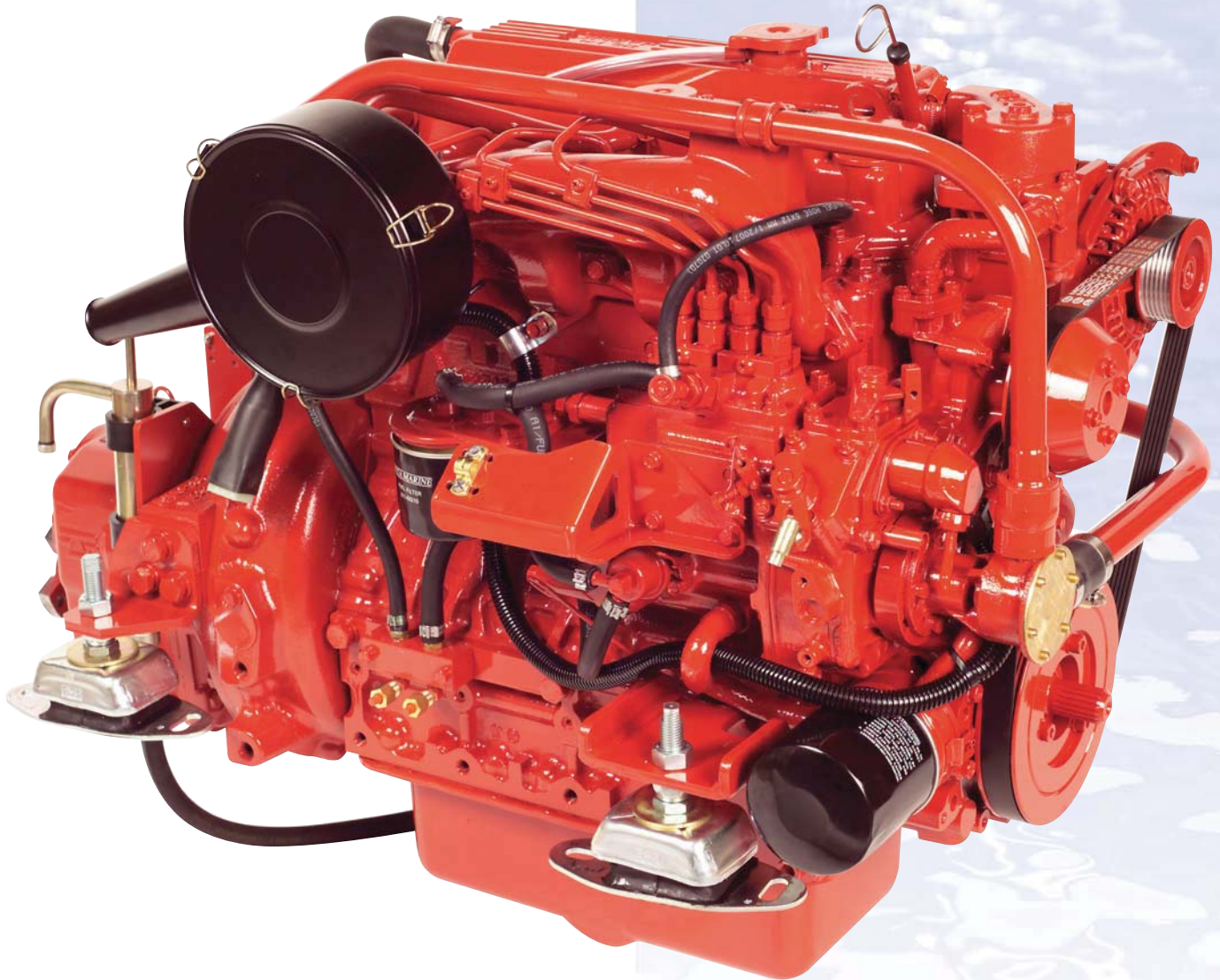

CONSUMATION GASOIL CORRESPONDANT À UNE CHARGE THÉORIQUE D'HÉLICE À PLEINE VITESSE